

OCR601-MK2 Series

Includes: MK2, MK2-N and MK2-SC

High-Performance Flatbed MRTD Reader with Contact/Contactless Capability

Description

The OCR601-MK2 is a machine readable zone (MRZ) data reader with RFID functionality to simultaneously decode the contents of an ePassport or contactless smart card.

The OCR601-MK2 automatically detects when a document with machine readable data has been inserted and its advanced recognition engine provides highly accurate and instant data capture and decoding.

By integrating the contactless RFID reader/writer, the device simultaneously and efficiently captures and processes data fields, including the holder's image, from the chip. This combined functionality provides a robust and cost-effective alternative to full-page, multi-illumination ID scanners.

The compact, robust design enables easy integration into self-service kiosks and gates, or use as a desktop device with rugged manufacturing ensuring years of indoor and outdoor, frontline, public use.

For users wanting to read contact cards, the OCR601-MK2-SC adds two contact smart card readers, two secure access modules (SAMs) and an integrated USB hub featuring two powered USB ports delivering even greater flexibility.

The OCR601-MK2-SC 4-in-1 ePassport, eID card, contactless and contact smart card reader



The OCR601-MK2 MRZ ePassport and eID card reader

Features

- Reads MRZ from ICAO 9303 compliant documents including Passports, e-Passports, ID cards and Visas as well as ISO 18013 compliant driving licences.
- Single action ePassport MRZ and chip reading
- High-speed recognition engine for instant detection/reading
- Low cost alternative to full-page, multi-illumination scanners
- Programmable audio 'beep' for user feedback.

Optional Features

- ISO 14443 contactless RFID reader/writer supports ICAO LDS standards including BAC, PA, AA, EAC and SAC.
- ISO 7816 contact reader/writer with two smartcards (ID-1) and two SAMs (ID-000) slots.
- Integrated USB hub featuring two powered ports for external peripherals.

Applications

- Border control and immigration
- Document issuance (passport, visa, etc.)
- Kiosks and self-service auto eGates
- Airport passenger data capture
- Hotels & hire car registration
- Identification verification.







	MRZ Reader	Contactless Reader	Smart Card Reader	SAM Reader
OCR601-MK2-N	✓			
OCR601-MK2	✓	✓		
OCR601-MK2-SC	✓	✓	✓x2	✓x2

Access IS
18 Suttons Business Park
Reading, Berkshire
RG6 1AZ, United Kingdom
Tel: +44 (0) 118 966 3333
Fax: +44 (0) 118 926 7281

Access (North America) inc
Atlanta, Georgia
USA
Airport & Airlines: +1-770-645-2771
ID & Security: +1-703-403-6848
Transport & Ticketing: +44 118 966 3333

Access IS
Interfacing Solutions

Example of device capabilities

PASSPORT INFORMATION		eMRTD SECURITY	
Last name	ELLIS		Basic Access Control
First name	TIM		Chip Authentication
Date of birth	01/01/1970		Active Authentication
Expiry date	08/12/2020		Passive Authentication
Nationality	CANADIAN		Terminal Authentication
Document No.	PMG920909		
			
		Photo	Fingerprint

Dimensions

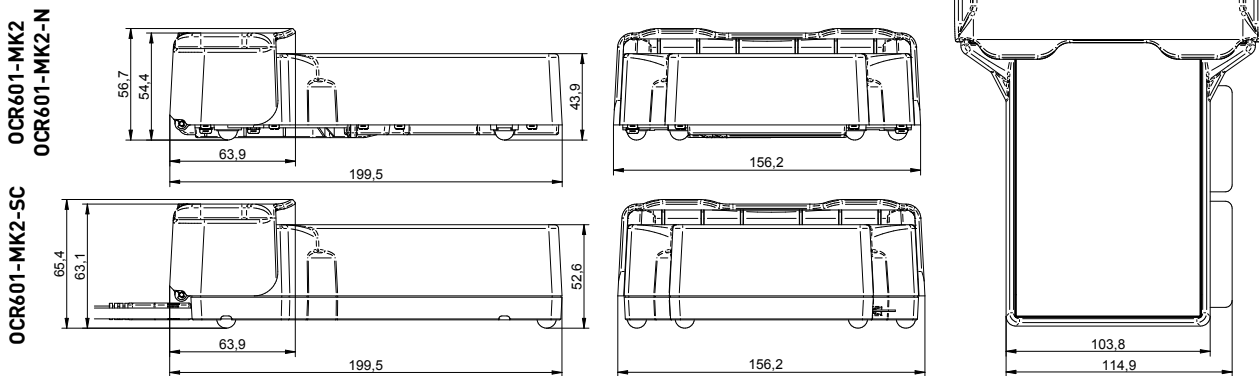

Specifications

MRZ/MRTD reading

Supported Font: OCR-B

Supported Standards:

ICAO 9303 specification Parts 1-4
ISO 18013 Driving Licence

Supported Documents:

3 lines MRZ
- ID1: eID, Resident Permit...

2 lines MRZ
- ID3: Passport, Visa...
- ID2: ID Card...

1 line MRZ
- ID1: Driving Licence...

Imaging

Active viewing area: 132mm x 30mm

Illumination source: IR, 880nm LED

Resolution: 235 DPI

Image capture: JPG, BMP, TIFF, PNG

Contact smart card reading

Number of ID-1 (smart card) slots: 2

Number of ID-000 (SAM) slots: 2

Compliance: ISO 7816, T=0, T=1

Application interface: PC/SC compliant device

Contactless RFID reading

Interoperability: ICAO DOC 9303, LDS1.7, ISO18013 (Driving Licence), PA, AA, BAC, EAC v1.11 (CA, TA), EAC v2.0x (PACE v2, ICAO SAC, CA v2, TA v2)

Operating frequency: 13.56 MHz

Supported documents: ISO 14443 type A & B auto-detecting; secure and high-speed data transmission; Mifare memory card support (Mifare ultralight, 1K, 4K cards)

Application interface: PC/SC compliant device

Mechanical

External dimensions: (LxWxH)

200 x 156 x 57mm (MK2-SC: 66mm)

Weight: 860g (MK2-SC: 900g)

Maximum document width: 132mm

Power supply

+5 VDC via DC jack

Cable: Detachable host cable

Communications & host

Communication: USB 2.0 high speed

Host: Windows 7 and above, Win 32/64 bit; Pentium-4 3GHz and 2GB RAM min

Environmental

Temperature: Operating 0 to 50°C;

Storage: -20 to 60°C

Humidity: 0 to 95% non-condensing

Approvals: FCC Part 15C Class A
CE EMC directive

Ver: 2.1 July 2015

Access IS
18 Suttons Business Park
Reading, Berkshire
RG6 1AZ, United Kingdom
Tel: +44 (0) 118 966 3333
Fax: +44 (0) 118 926 7281

Access (North America) inc
Atlanta, Georgia
USA
Airport & Airlines: +1-770-645-2771
ID & Security: +1-703-403-6848
Transport & Ticketing: +44 118 966 3333

Access IS
Interfacing Solutions

For further information email: sales@access-is.com or visit our website: www.access-is.com

All trademarks acknowledged. Specifications subject to change without prior notice. This literature is for outline information only.